





V150F

3~ 50 Hz. 400V	
FPT INDUSTRIAL	
EU STAGE 5	
69 dB(A) @ 7 mt	
250 lt	

PRIME POWER		STAND-BY POWER	
kVA	kW	kVA	kW
150	120	165	132

ENVIRONMENTAL CONDITIONS	
Temperature	40° C
Height	1000 mslm
Humidity	60%

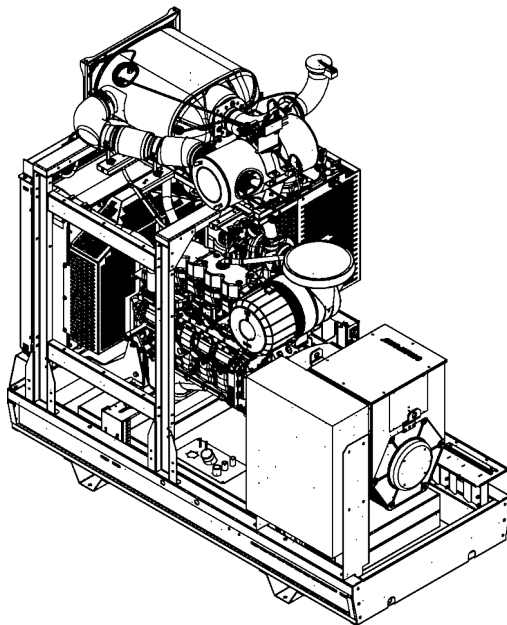
OPEN VERSION B200

SOUNDPROOF VERSION C200

The image is only for demonstration purposes

WEIGHT	DIMENSIONS		
	L [mm]	W [mm]	H [mm]
kg			
1900	2400	1100	2000

WEIGHT	DIMENSIONS		
	L [mm]	W [mm]	H [mm]
kg			
3070	3600	1200	2300

TECHNICAL DETAILS

ELECTRICAL DATA	Electrical system type	3F+N	~
	Power factor	0,8	φ
	Voltage	400	V
	Frequency	50	Hz
	PRP Ampere rating	216,5	A
ENGINE	Engine	FPT NEF N67TEVP06.00	
	Engine emissions standard	EU STAGE 5	
	RPM governor	Electronic –	
	Performance class	G2	
	Rpm	1500	rpm
	Nr. of cylinders	6	
	Bore x stroke	104 x 132	mm
	Displacement	6728	cc
	Induction system	Turbocharged	
	Cooling system	Water	
	Engine net prime power	182,3 (136)	Hp (kW)
	Exhaust gas aftertreatment	DOC + SCR + CUC	
CONSUMPTION	Fuel type	Diesel	
	Consumption –load - charge	17 – 24,6 – 32,8	lt/h
	Standard tank capacity	250	lt
	Autonomy –load - charge	10,2	h
	AdBlue tank capacity	43	lt
	AdBlue autonomy – load - charge	TBD	h
ALTERNATOR	Alternator	STAMFORD – MECC ALTE – MARELLI MOTORI	
	Type	Self excited, brushless	
	Number of poles	4	
	Insulation class	H	
	Temperature rise class	H	
	Voltage regulation	AVR	
	Voltage precision	± 1	%
GENERAL	Sound level (soundproof version)	69	dB(A) 7mt
	Exhaust pipe diameter	101	mm
	Electrical system voltage	24	V

ELECTRIC PANEL

MANUAL

AUTOMATIC MAINS FAILURE

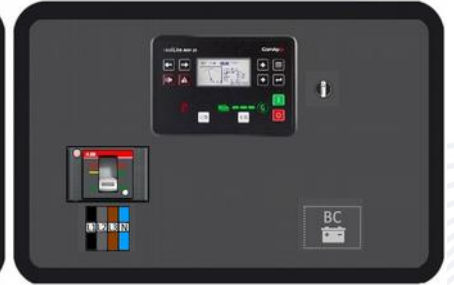

Electronic control unit with multimeter	COMAP IntelLite AMF8	
Electrical panel enclosure protection degree	IP44	
ON-OFF electric panel switch	Key type	Without key
Emergency pushbutton	STANDARD	
Battery charge maintainer	/	24V 5A
Power supply	Full power terminal	
Circuit breaker	Magnetothermal type 4P ABB Tmax-XT 250A	
Main protection alarms	Min-max V and Hz. LOP. HWT. Battery charger alternator failure. Low fuel level	

STANDARD ELECTRONIC CONTROL UNIT

COMAP
AMF8



Functions: automatic or manual start, remote start, periodic test

Multimeter V (L1, L2, L3, N), A (L1, L2, L3), Hz, kVA, battery V, hour counter

Backlit LCD display. USB port

Communication accessories available: Ethernet, GSM-GPRS, 4G, GPS

OPTIONAL ELECTRONIC CONTROL UNIT



DEEP SEA DSE7320 MKII



COMAP AMF25

SOUNDPROOF AND WEATHERPROOF CANOPY



<i>Self-supporting frame material</i>	<i>Carbon steel sheet, electro-welded, minimum thickness 3 mm</i>
<i>Soundproof canopy material</i>	<i>Carbon steel sheet, electro-welded, thickness between 1,5 and 4,5 mm</i>
<i>Painting</i>	<i>Epoxy powder RAL5015 textured, outdoor-proof</i>
<i>In-built fuel tank</i>	250 lt + Drip tray
<i>Soundproofing coating material</i>	<i>Polyester fiber. Fire resistance EN13501-1 class B</i>
<i>Muffler</i>	<i>/</i>
<i>Access openings</i>	<i>n.3 doors with padlockable key lock</i>
<i>Electric panel</i>	<i>Lateral side position. Dedicated door with padlockable key lock</i>
<i>Fresh air intake and hot air expulsion</i>	
<i>Lifting system</i>	<i>n.2 lifting hooks</i>
<i>Support feet</i>	<i>n.4 support feet with holes for machine ground fastening</i>

CONTAINER TRANSPORTABILITY ADVANTAGES

VERSION	20' BOX	40' BOX	40' HC
<i>N. transportable pieces</i>	4	10	10
	2	6	6

MAIN OPTIONS



250A automatic transfer switch (ATS)



400 lt bigger fuel tank with drip tray



750W engine preheating system



Automatic fuel transfer kit with manual by-pass system



Residual current protection relay adjustable in sensitivity and intervention time

OTHER OPTIONS

Power distribution socket set

Synchronizing electric panel

Battery switch

Remote control systems

Further alternator brand

Quick couplings for connecting an external tank with three way valve

Outdoor, underground and transportable tanks

Slow or fast towing trailer

Front hot air expulsion canopy

Further colors

VERSIONS WITH SPECIAL EQUIPMENT



RENTAL

Special version with features designed for the rental market



ZERO NOISE

Super sound-proofed special version, noise level 50, 55 or 60 dB(A)

Greenpower AB
Helsingborgsvägen Varalöv,
262 96 Ängelholm, Sweden
Phone: +46 43122240
Email: info@greenpower.se
Web: www.greenpower.se